



Easy to Assemble



Strong, stylish, flexible storage for your home.

Whether you need to get your wardrobe sorted, give your bedroom (or your kid's room) a make-over, or provide a place for your flash new TV, GetSorted has the answer.

GetSorted storage looks great, with simple contemporary styling that doesn't cost the earth. Furniture and wardrobes can be configured to fit spaces of all shapes and sizes, and use eco-friendly timber panels to keep your home safe. Best of all GetSorted is super easy to put together with simple instructions – headache free.

GetSorted is packed with great features:

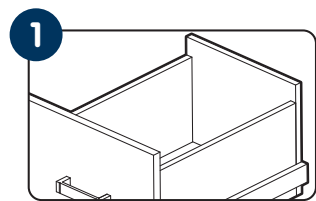

High back drawers stop contents escaping

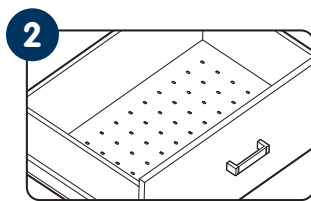

Vented & sturdy metal drawer base

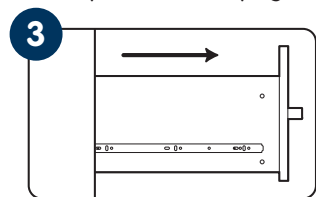

Full extension drawer runners for easy access

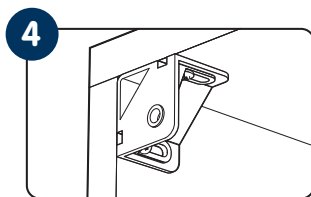

Corner bracing for strength & rigidity

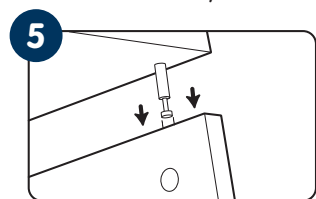

Secure top mount fixing

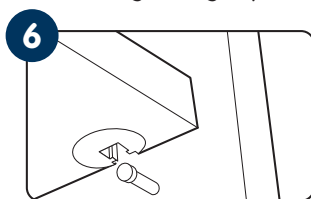

Friction lock shelves remain stable

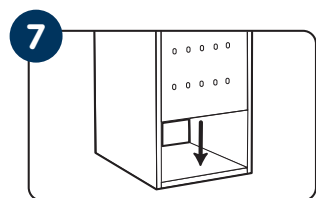

Vented stabilising rear panel

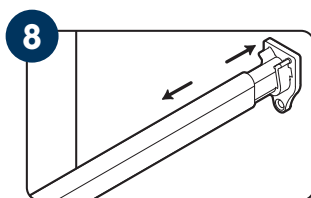

Expandable wardrobe rails

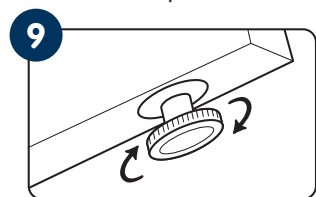

Adjustable feet keep things level

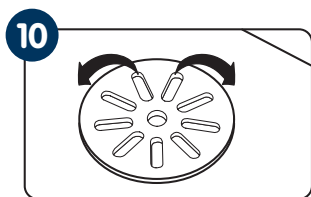

Totally vented system keeps contents fresh



Mix, match & stack storage to suit your needs.

GetSorted is a breeze to assemble and because it's modular, you can add to it or change it at any time.

Wardrobe PAGES 4 & 5

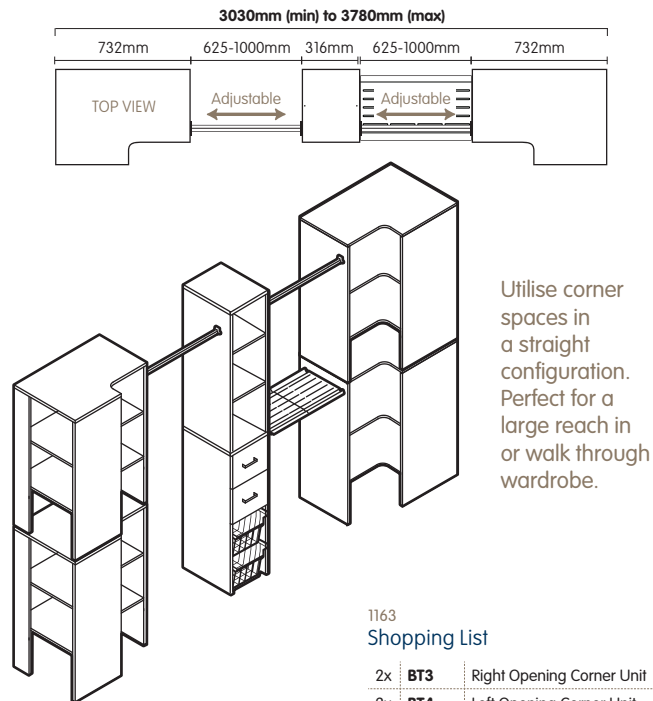

1163 Shopping List

2x	BT3	Right Opening Corner Unit
2x	BT4	Left Opening Corner Unit
1x	BT5KIT	Half Width Wardrobe Kit
2x	BA1	Half Width Drawer
2x	BA7	Half Width Wire Basket
1x	BA12	Adjustable Shelf



Furniture PAGES 6 & 7

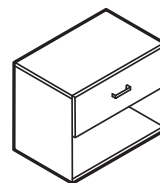

Super affordable bedside.

1031 Shopping List

1x	BC12	Half Height Cabinet
1x	BA2	Standard Drawer

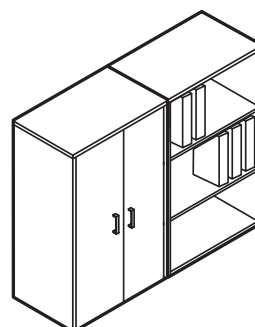

This credenza is perfect for the office or kids room.

1086 Shopping List

2x	BC11	Standard Cabinet
2x	BA6	Standard Shelf Set
2x	BA4	Door

Wardrobes

Choose from these popular combinations or use them as a starting point to create your own wardrobe design. Available in white or maple.

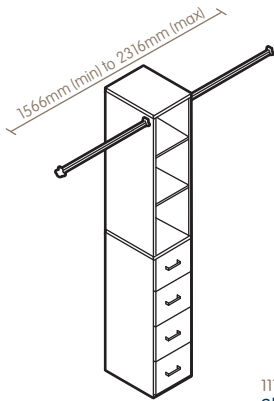

For a single or double wardrobe, use the adjustable hanging rods at full or half height.

1111 Shopping List

1x	BT5KIT	Half Width Wardrobe Kit
4x	BA1	Half Width Drawer

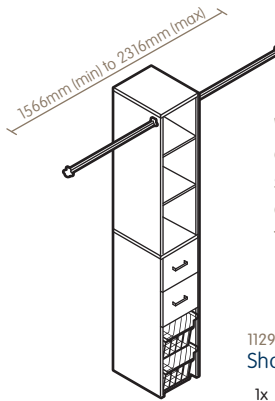

Wire baskets are great for socks whilst drawers keep things private.

1129 Shopping List

1x	BT5KIT	Half Width Wardrobe Kit
2x	BA1	Half Width Drawer
2x	BA7	Half Width Wire Basket

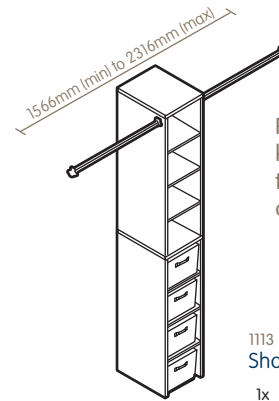

Fabric baskets keep everything tidy - use them on any shelf.

1113 Shopping List

1x	BT5KIT	Half Width Wardrobe Kit
1x	BA5	Half Width Shelf Set
4x	BA9	Half Width Fabric Basket

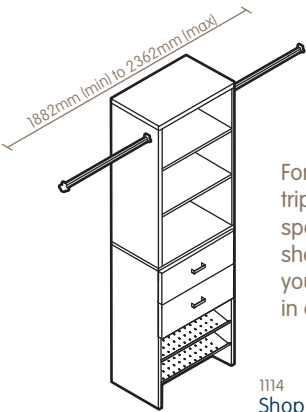

For a double or triple wardrobe space. Shoe shelves keep your shoes in order.

1114 Shopping List

1x	BT6KIT	Standard Wardrobe Kit
2x	BA2	Standard Drawer
1x	BA13	Shoe Shelf Set

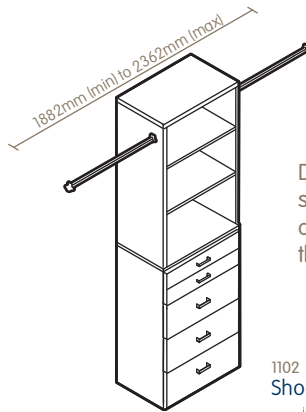

Drawers maximise storage capacity and keep things tidy.

1102 Shopping List

1x	BT6KIT	Standard Wardrobe Kit
2x	BA3	Half Height Drawer
3x	BA2	Standard Drawer

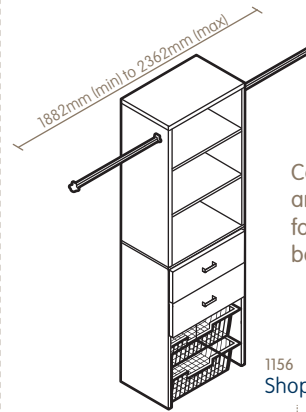

Combine drawers and baskets for the best of both worlds.

1156 Shopping List

1x	BT6KIT	Standard Wardrobe Kit
2x	BA2	Standard Drawer
2x	BA8	Standard Wire Basket

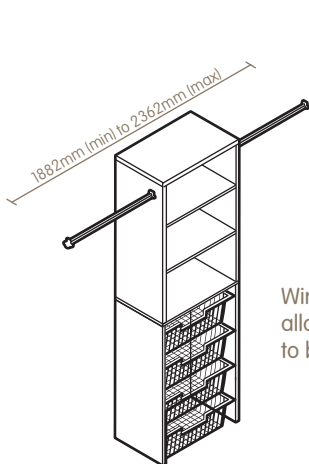

Wire baskets allow clothes to breathe.

1107 Shopping List

1x	BT6KIT	Standard Wardrobe Kit
4x	BA8	Standard Wire Basket

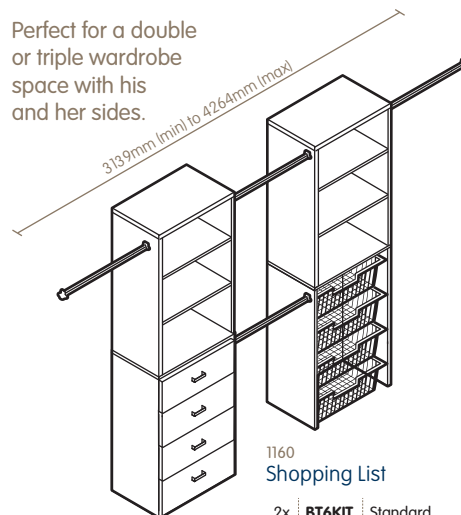

Perfect for a double or triple wardrobe space with his and her sides.

1160 Shopping List

2x	BT6KIT	Standard Wardrobe Kit
4x	BA2	Standard Drawer
4x	BA8	Standard Wire Basket

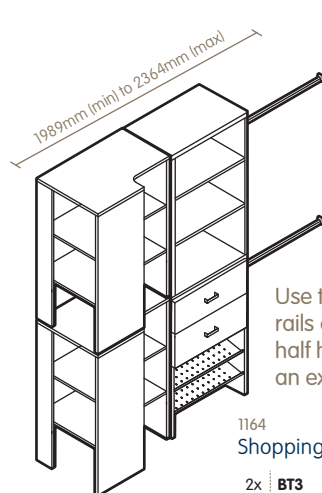

Use the hanging rails at full height or half height. Or add an expanding shelf!

1164 Shopping List

2x	BT3	Right Opening Corner Unit
1x	BT6KIT	Standard Wardrobe Kit
2x	BA2	Standard Drawer
1x	BA13	Shoe Shelf Set

Wardrobe Components

Combine base cabinets with accessories to create the combination that fits your space. Make your shopping list, purchase, and assemble – it's a breeze.

Available In:



Maple



White

STANDARD WIDTH

BT6KIT

Standard Wardrobe Kit

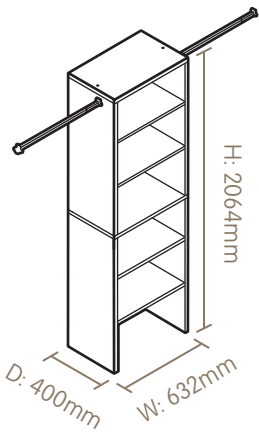

A great basic wardrobe straight out of the box or add accessories

QTY

HALF WIDTH

BT5KIT

Half Width Wardrobe Kit

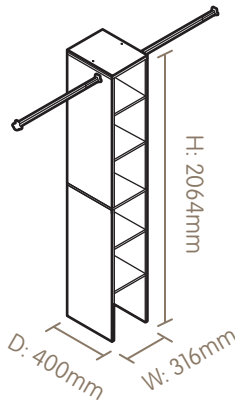

QTY

CORNERS

BT3

Right Opening

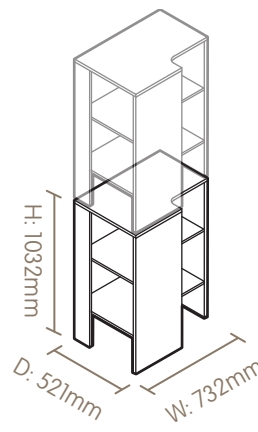

QTY

BT4

Left Opening

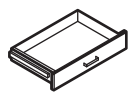
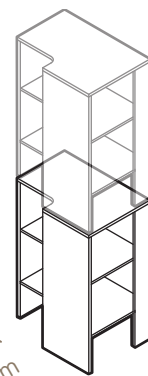

BA3
Half Height
Drawer

QTY

N/A

N/A

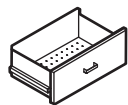

BA2
Standard
Drawer

QTY



BA1
Half Width
Drawer

QTY

N/A



BA8
Standard
Wire Basket

QTY



BA7
Half Width
Wire Basket

QTY

N/A

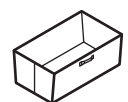

BA10
Standard
Fabric Basket
in Beige or Grey

QTY



BA9
Half Width
Fabric Basket
in Beige or Grey

QTY

N/A

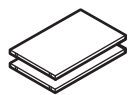

BA6
Standard
Shelf Set

QTY



BA5
Half Width
Shelf Set

QTY

N/A

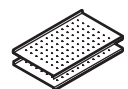

BA13
Shoe Shelf Set

QTY

N/A

N/A



BA11
Adjustable
Hanging Rod

QTY



BA11
Adjustable
Hanging Rod

QTY



BA11
Adjustable
Hanging Rod

QTY

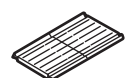

BA12
Adjustable Shelf

QTY

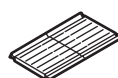

BA12
Adjustable Shelf

QTY

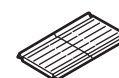

BA12
Adjustable Shelf

QTY

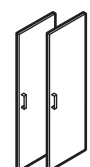

2x BA4
Doors

QTY



BA4
Door

QTY

N/A

Step 1 - Select your base.

Step 2 - Add accessories.

Furniture

GetSorted combinations are limited only by your imagination. Mix, match, and stack components to create a combination that works for you!

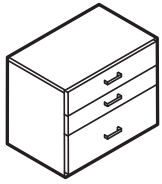

Bedside or office drawers.

1082
Shopping List

1x	BC12	Half Height Cabinet
2x	BA3	Half Height Drawer
1x	BA2	Standard Drawer

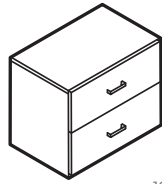

Bedside or office drawers - multiply for low line storage.

1030
Shopping List

1x	BC12	Half Height Cabinet
2x	BA2	Standard Drawer

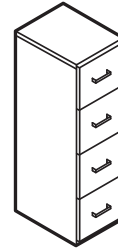

Half width tallboy saves on space.

1035
Shopping List

1x	BC10	Half Width Cabinet
4x	BA1	Half Width Drawer

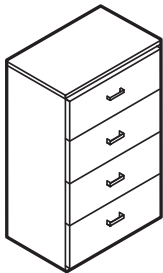

Tallboy - perfect for the bedroom or office.

1033
Shopping List

1x	BC11	Standard Cabinet
4x	BA2	Standard Drawer

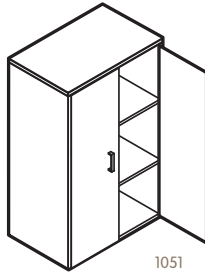

Cupboard with adjustable shelves - great for the office, laundry, or garage.

1051
Shopping List

1x	BC11	Standard Cabinet
1x	BA6	Standard Shelf Set
2x	BA4	Door

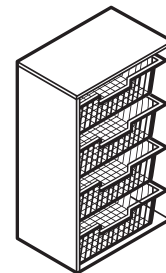

Wire baskets are great for sports gear or stray toys.

1150
Shopping List

1x	BC11	Standard Cabinet
4x	BA8	Standard Wire Basket

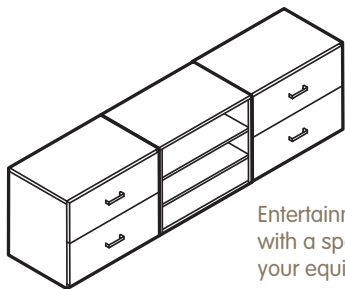

Entertainment unit with a spot for all your equipment.

1145
Shopping List

3x	BC12	Half Height Cabinet
4x	BA2	Standard Drawer
1x	BA6	Standard Shelf Set

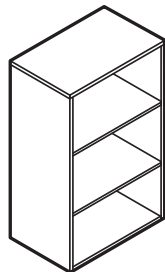

Shelves are always handy - grab some baskets to organise your things.

1050
Shopping List

1x	BC11	Standard Cabinet
1x	BA6	Standard Shelf Set

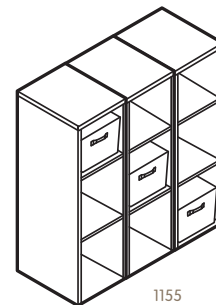

Cube shelving is great for the kids books and toys - to keep things tidy, add a few fabric baskets.

1155
Shopping List

3x	BC10	Half Width Cabinet
3x	BA5	Half Width Shelf Set
3x	BA9	Half Width Fabric Basket

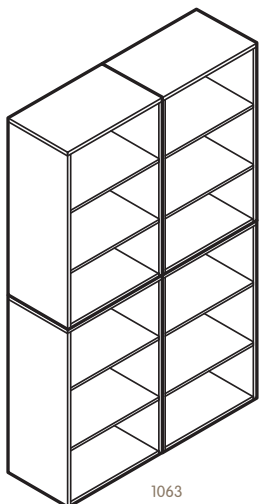

Bookshelves - stack up or use side by side.

1063
Shopping List

4x	BC11	Standard Cabinet
4x	BA6	Standard Shelf Set

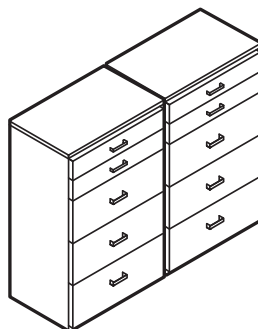

The ultimate dresser - his and hers storage.

1037
Shopping List

2x	BC11	Standard Cabinet
4x	BA3	Half Height Drawer
6x	BA2	Standard Drawer

Entertainment unit with oodles of storage space.



1144
Shopping List

2x	BC11	Standard Cabinet
2x	BC12	Half Height Cabinet
2x	BA6	Standard Shelf Set
8x	BA2	Standard Drawer

Furniture Components

GetSorted combinations are limited only by your imagination. Make your shopping list, purchase, and assemble – it's that easy.

Available In:



Maple

White

STANDARD WIDTH/HEIGHT

BC11

Standard Cabinet

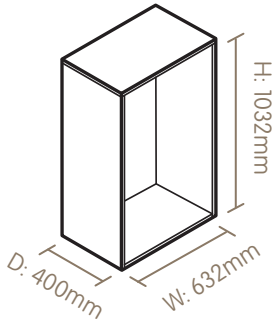

QTY

Note: BC11 fits max 4 standard drawers/baskets or 8 half height drawers or combination

HALF WIDTH

BC10

Half Width Cabinet

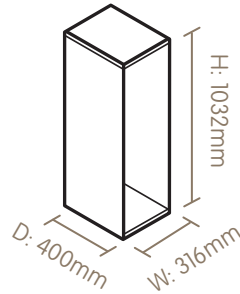

QTY

Note: BC10 fits max 4 half width drawers/baskets or combination

HALF HEIGHT

BC12

Half Height Cabinet

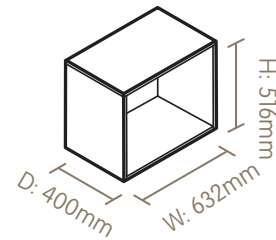

QTY

Note: BC12 fits max 2 standard drawers/baskets or 4 half height drawers or combination

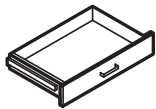

BA3
Half Height
Drawer

QTY

N/A

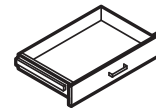

BA3
Half Height
Drawer

QTY

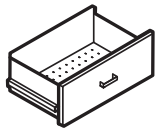

BA2
Standard Drawer

QTY



BA1
Half Width
Drawer

QTY

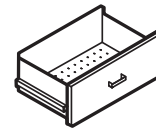

BA2
Standard Drawer

QTY



BA8
Standard
Wire Basket

QTY



BA7
Half Width
Wire Basket

QTY



BA8
Standard
Wire Basket

QTY

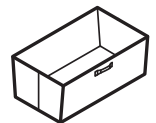

BA10
Standard
Fabric Basket
in Beige or Grey

QTY



BA9
Half Width
Fabric Basket
in Beige or Grey

QTY

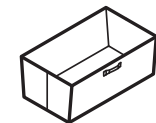

BA10
Standard
Fabric Basket
in Beige or Grey

QTY

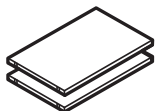

BA6
Standard Shelf Set

QTY

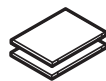

BA5
Half Width
Shelf Set

QTY

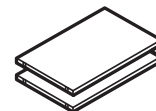

BA6
Standard Shelf Set

QTY

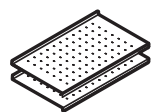

BA13
Shoe Shelf Set

QTY

N/A

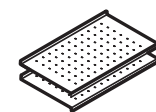

BA13
Shoe Shelf Set

QTY

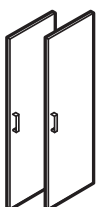

2x BA4
Doors

QTY



BA4
Door

QTY

N/A

Legs shown in photos available 2014.

Step 1 - Select your base.

Step 2 - Add accessories.

Mix, match & stack to suit your needs.

GetSorted is a breeze to assemble and because it's modular, you can add to it or change it at any time.

Packed with great features!

SEE PAGE 2

Wardrobe PAGES 4 & 5

A his and hers set with space for all your shoes.

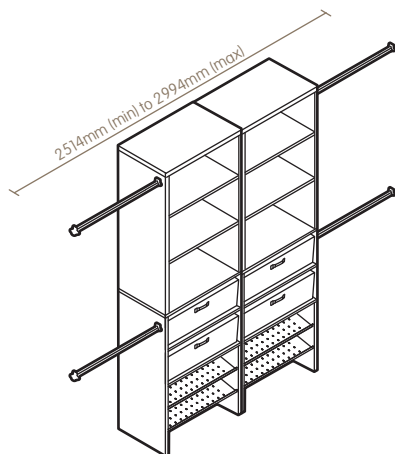

1170 Shopping List

2x	BT6KIT	Standard Wardrobe Kit
4x	BA10	Standard Fabric Drawer
2x	BA13	Shoe Shelf Set

Great for walk in wardrobes. Use the towers together or on either side of hanging rods.

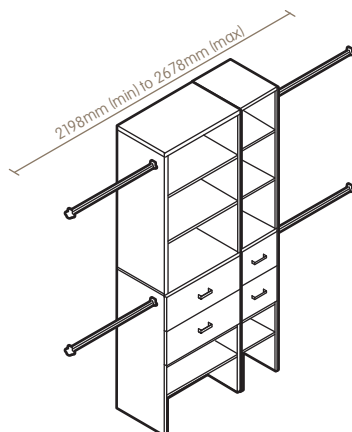

1161 Shopping List

1x	BT6KIT	Standard Wardrobe Kit
1x	BT5KIT	Half Width Wardrobe Kit
2x	BA2	Standard Drawer
2x	BA1	Half Width Drawer

Walk in solution, makes use of the corner and maximises hanging space.

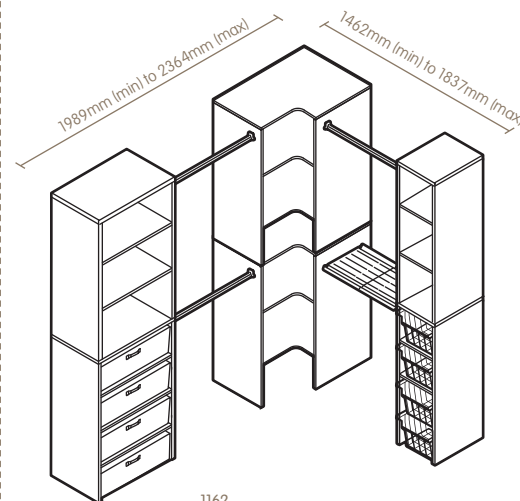

1162 Shopping List

2x	BT4	Left Opening Corner Unit
1x	BT6KIT	Standard Wardrobe Kit
1x	BT5KIT	Half Width Wardrobe Kit
4x	BA10	Standard Fabric Basket
1x	BA6	Standard Shelf Set
1x	BA12	Adjustable Metal Shelf
4x	BA7	Half Width Wire Basket

Furniture PAGES 6 & 7



The perfect tallboy on its own, or double up for his and hers.

1034 Shopping List

1x	BC11	Standard Cabinet
2x	BA3	Half Height Drawer
3x	BA2	Standard Drawer

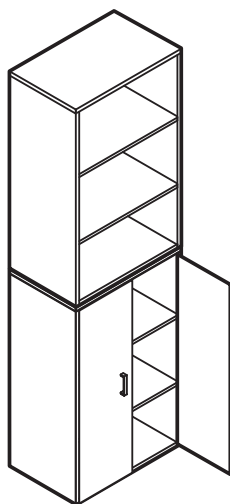

Office wall unit - adjust the shelves to suit your filing needs.

1084 Shopping List

2x	BC11	Standard Cabinet
2x	BA6	Standard Shelf Set
2x	BA4	Door

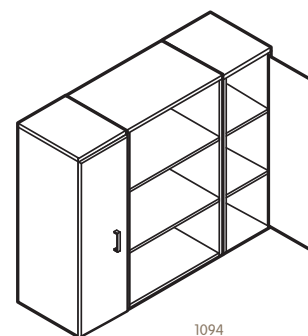

Credenza - hide away or display your stuff.

1094 Shopping List

2x	BC10	Half Width Cabinet
1x	BC11	Standard Cabinet
2x	BA5	Half Width Shelf Set
1x	BA6	Standard Shelf Set
2x	BA4	Door